

paper waste bags 35l



technical data sheet

product	Sumus® bag, flat bottom, self-shaped.
materials	100% recycled, post consumer kraft paper
weight	75 g/m ²
glues and inks	Water - based.
certifications	"HPB High Performance Bag" - UNI EN 13593:2003 FSC® - Forest Stewardship Council CQ-COC-000217 ATICELCA® 501 - level B

size

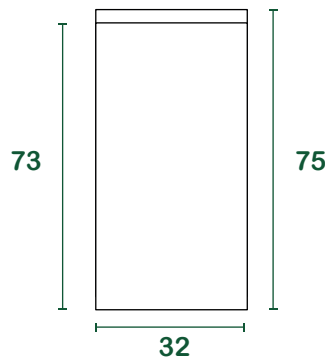
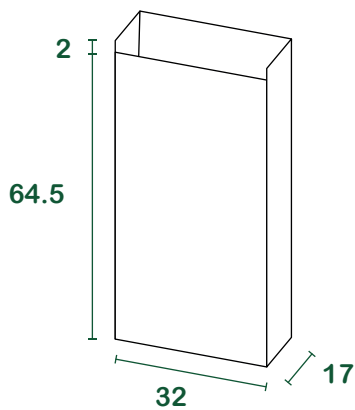

l = litres | size in cm

packaging

base [pieces/wad]	25 / 50 / 100
pieces/pallet	10.000
pallet size [cm]	80 _x 140 _x 175
gross weight pallet [kg]	640
full load [pallets]	27
full load [pieces]	270.000