

360 litres organic waste

technical data sheet | non domestic use

product Sumus® bag, with open top and crossed bottom.

materials 100% recycled, post consumer kraft paper, certified for composting

weight 75+75 g/m² (two layers)
90 g/m² (one layers, from 240l)

glues and inks Water - based.

certifications Compostabile CIC - UNI EN 13432:2002
HPB High Performance Bag - UNI EN 13593:2003
FSC® - Forest Stewardship Council CQ-COC-000217



size

l = litri | misure in cm

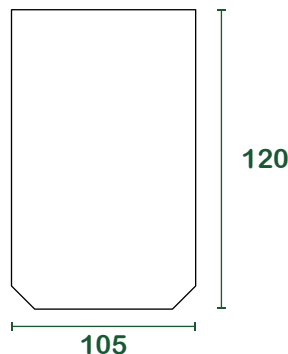
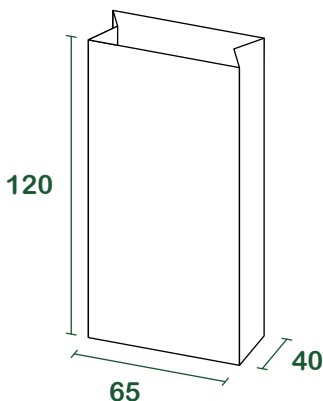

packaging

base [pieces/wad]	25
pieces/pallet	1.500
pallet size [cm]	80 _x 120 _x 150
gross weight pallet [kg]	1.250
full load [pallets]	32
full load [pieces]	76.800

CONTACTS:
Sumus® Italia srl Via Nicola Piccinni, 5 | 20131 - Milan MI - Italy
sumusitaliasrl@legalmail.it
www.sumusitalia.it - info@sumusitalia.it

PLEASE NOTE:
All information on the packaging may undergo changes due to productio needs or specific agreements with Sumus® Italia Srl

SISTEMI DI GESTIONE CERTIFICATI

