



organic waste bags 30l



technical data sheet

product	Sumus® bag, with open top and crossed bottom.
materials	100% recycled, post consumer kraft paper, certified for composting
weight	75+75 g/m ² (two layers) 90 g/m ² (one layers, from 240l)
glues and inks	Water - based.
certifications	"Compostabile CIC" - UNI EN 13432:2002 "HPB High Performance Bag" - UNI EN 13593:2003 FSC® - Forest Stewardship Council CQ-COC-000217 Blauer Engel

size

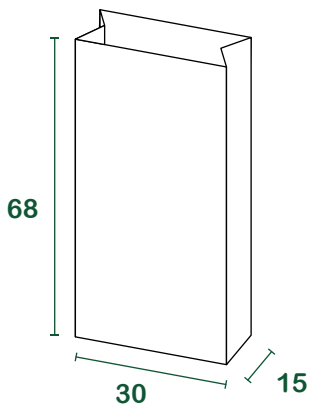

l = litres | size in cm

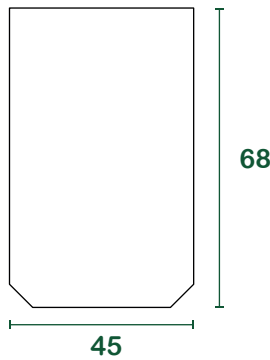

packaging

base [pieces/wad]	20
pieces/pallet	5000
pallet size [cm]	110 _x 120 _x 170
gross weight pallet [kg]	800
full load [pallets]	23
full load [pieces]	115.000