

# organic waste bags 360l



## technical data sheet

<b>product</b>	Sumus® bag, with open top and crossed bottom.
<b>materials</b>	100% recycled, post consumer kraft paper, certified for composting
<b>weight</b>	75+75 g/m <sup>2</sup> (two layers) 90 g/m <sup>2</sup> (one layers, from 240l)
<b>glues and inks</b>	Water - based.
<b>certifications</b>	"Compostabile CIC" - UNI EN 13432:2002 "HPB High Performance Bag" - UNI EN 13593:2003 FSC® - Forest Stewardship Council CQ-COC-000217 Blauer Engel

## size

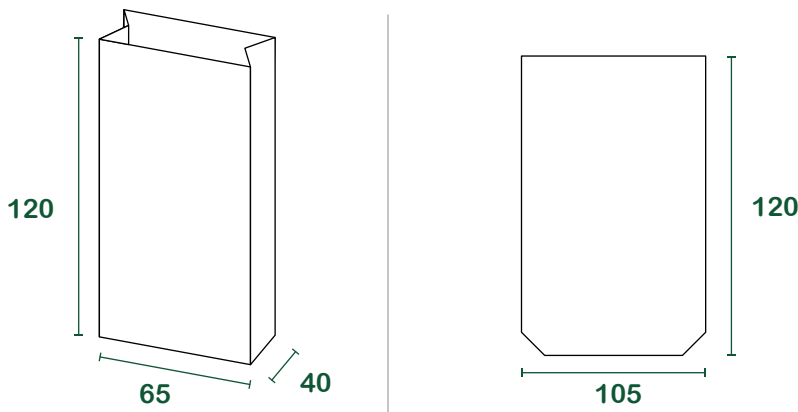

l = litres | size in cm

## packaging

base [pieces/wad]	25
pieces/pallet	1500
pallet size [cm]	80 <sub>x</sub> 120 <sub>x</sub> 150
gross weight pallet [kg]	1.250
full load [pallets]	32
full load [pieces]	76.800