

# paper waste bags 50l



## technical data sheet

**product** Sumus® bag, flat bottom, self-shaped (120l crossed bottom).

**materials** 100% recycled, post consumer kraft paper

**weight** 75 g/m<sup>2</sup>

**glues and inks** Water - based.

**certifications** "HPB High Performance Bag" - UNI EN 13593:2003  
FSC® - Forest Stewardship Council  
Blauer Engel

## size

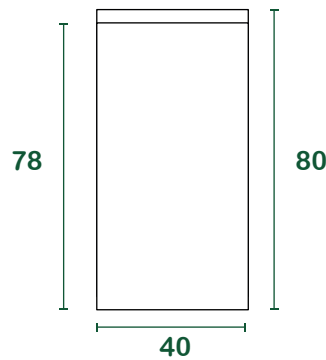
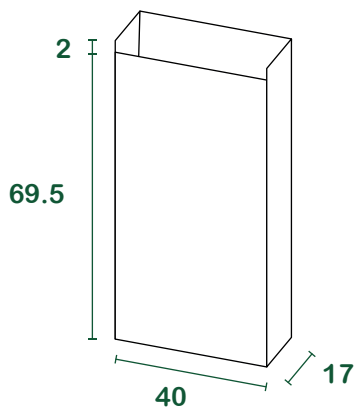

l = litres | size in cm

## packaging

**base [pieces/wad]** 25 / 50 / 100

**pieces/pallet** 10.000

**pallet size [cm]** 80<sub>x</sub>120<sub>x</sub>175

**gross weight pallet [kg]** 610

**full load [pallets]** 32

**full load [pieces]** 320.000