



Müllsäcke für organische Abfälle 30l



datenblatt

Produkt	Sumus® offener Kreuzbodensac.
Materialien	100% recyceltes Kraftpapier Avana aus Post Consumer Abfällen; zertifiziert kompostierbar.
Grammatur	75+75 g/m ² (Doppelblatt) 90 g/m ² (Einzelblatt, ab 240l)
Leime und Tinten	Leim auf Wasserbasis, schwarze Tinte auf Wasserbasis mit Kohlefaserpigmenten.
Zertifizierungen	"Compostabile CIC" - UNI EN 13432:2002 "HPB High Performance Bag" - UNI EN 13593:2003 FSC® - Forest Stewardship Council CQ-COC-000217 Blauer Engel

Abmessungenen

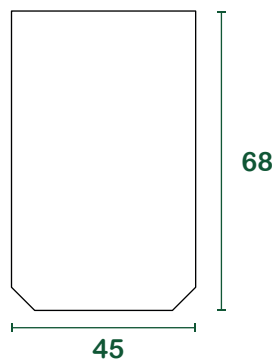
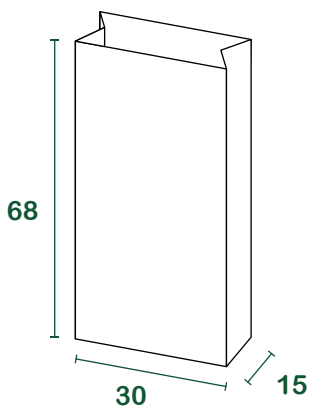

l = Liter | Abmessungenen cm

Verpackung

Stück pro Umschlag	20
Stück pro Palette	5000
Palettengröße einer Ladung [cm]	110 _x 120 _x 170
Bruttogewicht einer Palette [kg]	800
Paletten je Volllast	23
Stück je Volllast	115.000