



paper waste bags 60l

technical data sheet

product	Sumus® bag, flat and crossed bottom.
materials	100% recycled, post consumer kraft paper
weight	90 g/m ² 75 + 75 g/m ²
glues and inks	Water - based.
certifications	"HPB High Performance Bag" - UNI EN 13593:2003 FSC® - Forest Stewardship Council CQ-COC-000217 ATICELCA® 501 - level B

size

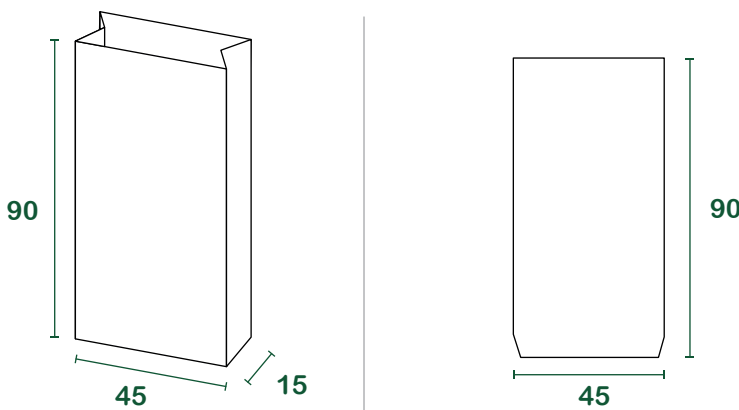

l = litres | size in cm

packaging

base [pieces/wad]	20
pieces/pallet	5.000
pallet size [cm]	100 _x 120 _x 175
gross weight pallet [kg]	525
full load [pallets]	23
full load [pieces]	115.000