

recogida de papel 50l



ficha técnica

producto	Bolsa Sumus® con parte inferior plano con autoformado
materiales	Papel kraft habanero reciclado 100% posconsumo
peso	75 g/m²
pegamentos y tinta	Pegamento a base de agua con integración vinílica, tinta a base de agua Color negro con pigmento de fibra de carbono.
certificaciones	"HPB High Performance Bag" - UNI EN 13593:2003 FSC® - Forest Stewardship Council CQ-COC-000217 Blauer Engel

medidas

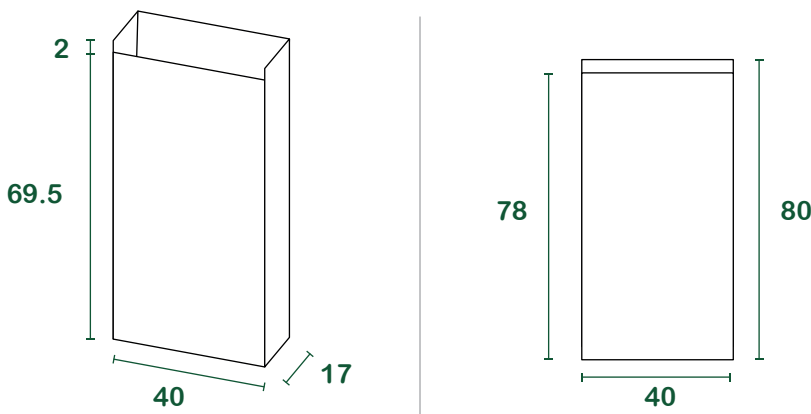

l = litros | medidas in cm

embalaje

base [PC / paquete]	25 / 50 / 100
PC / palet	10.000
dimensiones de carga [cm]	80 _x 120 _x 175
peso bruto del palé	610
carga completa [palet]	32
carga completa [pcs]	320.000