

120 litres organic waste

technical data sheet | non domestic use

product	Sumus® bag, with open top and crossed bottom.
materials	100% recycled, post consumer kraft paper, certified for composting
weight	75+75 g/m ² (two layers) 90 g/m ² (one layers, from 240l)
glues and inks	Water - based.
certifications	Compostabile CIC - UNI EN 13432:2002 HPB High Performance Bag - UNI EN 13593:2003 FSC® - Forest Stewardship Council CQ-COC-000217



size

l = litri | misure in cm

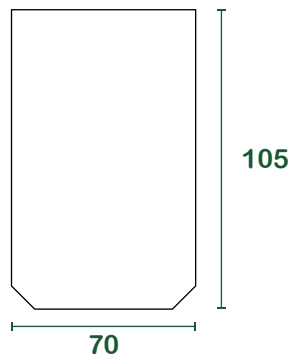
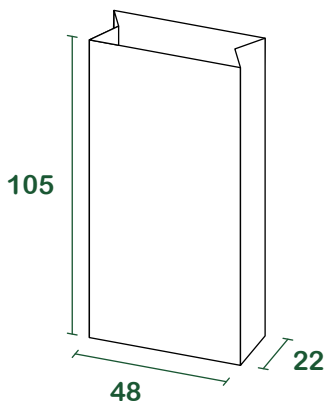

packaging

base [pieces/wad]	20
pieces/pallet	3.000
pallet size [cm]	110 _x 140 _x 160
gross weight pallet [kg]	900
full load [pallets]	23
full load [pieces]	69.000

CONTACTS:
Sumus® Italia srl Via Nicola Piccinni, 5 | 20131 - Milan MI - Italy
sumusitaliasrl@legalmail.it
www.sumusitalia.it - info@sumusitalia.it

PLEASE NOTE:
All information on the packaging may undergo changes due to productio needs or specific agreements with Sumus® Italia Srl



SISTEMI DI GESTIONE CERTIFICATI

